

# **KAPPRO**® TOOLS WITH VISION

**INNOVATION & DESIGN**

**VISIBLY BETTER**



# **U.S. TAPE**®

WORLD CLASS TOOLS SINCE 1876

**2021 CATALOG**

## ABOUT KAPRO

**Kapro is a leading manufacturer and developer of Innovative hand tools for the professional and DIY markets.**

**We make the industry's finest quality spirit levels, laser levels and layout, marking and measuring tools. Kapro has built a reputation as the Industry's foremost innovator with over more than 100 patents world-wide, covering a comprehensive range of professional applications.**

### INNOVATION & DESIGN

Kapro's R&D team has revolutionized layout and measuring tool design and given the market some of its most ground-breaking features:

The invention of the **Plumb Site® Dual-View™** changed level design forever: the only level feature on the market providing front-on view of the plumb vial, eliminating parallax error as well as neck and back strain due to vertical plumb jobs.

The introduction of the **Optivision® Red** feature set a whole new standard in vial visibility by creating a strong color definition around the spirit level's bubble; the clearest, most visible vial on the market today.

In addition to these market-changing features, Kapro develops tools especially designed for different professions such as the drywall and gradient levels, electrician and plumbing levels, and many more. Kapro listens, making it the smartest choice in tools.

Kapro's impressive line of powerful **Prolaser®** levels with multiple combination sets offer a staggering array of choices for customers.

### QUALITY

Kapro is dedicated to excellence in every aspect of development: production, distribution, sales, and marketing.

Kapro is the only level manufacturer in the world to carry the prestigious VPA mark of quality and all our manufacturing facilities are certified compliant with ISO Standards 9001, 14001 and SA8000. All Kapro lasers and electronic products carry FDA and CE certification and comply with RoHS, WEEE and REACH regulations. The Kapro brand represents high quality tools with an innovative design edge.

### SERVICE & VALUE

The Kapro team has a culture of service; producing high quality marketing and advertising materials, maintaining a strong web presence and above all, consistently availing ourselves to our customers and responding to their needs.

The Kapro team offers outstanding customer service and high quality, innovative products with added value.

### GLOBAL DISTRIBUTION NETWORK

Kapro is a major global player with headquarters in Kadarim, Israel and facilities in China and the USA, all wholly owned by Kapro Industries. Our partners' distribution network has created a leading market presence in over 70 countries throughout Europe, North & South America, Asia, Australasia, and Africa.

**KAPRO. TOOLS WITH VISION™**

## VPA CERTIFICATION

The VPA Prüf- und Zertifizierungs GmbH is the leading certification organization that tests, evaluates and can certify the quality and adherence of tools to German laboratory standards and regulations.

The VPA CERTIFIED seal attests to the safety and the quality of the products with comprehensive testing procedures and continuous supervision.

### The VPA tests include:

- Level accuracy according to VPA laboratory standard
- Chemical testing of PAHs for plastics and compliance with German standards
- Reliability and breakage testing to determine the level's strength
- Safety tests according to German standard parameters
- Full-scope inspections according to all the applicable standards and guidelines
- Regular supervision processes

### The tests are based on the following principles:

- EC directives
- EN, ISO, IEC standards
- Legal regulations
- National technical standards
- Rules of technology and safety engineering
- Tested Safety (GS) mark



**At Kapro we have VPA certified products that testify to the high quality and standards with which we operate and manufacture levels you can rely on and we can be proud of.**

# 905DG CONDOR™ DIGITAL Level

Digital Level with Optivision® Red

- IP65 rating - Dust and water resistant
- 2 Solid acrylic vials, including:  
1 - OPTIVISION® Red tilted horizontal vial  
1 - Vertical vial
- Digital accuracy: <math><0.05^\circ</math> at level and plumb, <math><0.1^\circ</math> at other angles
- 45° Tilted LCD display with backlight
- 180° Readout - Readable when level is inverted
- HOLD function for transferring measurements
- MODE function (Degree/Percentage/Pitch)
- SLOPE function - Reads slope in inches over feet
- Recalibration function and 'False Zero'
- Buzzer at 0°, 45°, 90°
- Large silicone buttons, easy to use while wearing gloves
- Shockproof end caps
- Finely milled surfaces
- Wall grip feature
- Battery indicator
- AA Batteries included
- Water resistant padded case with accessory pouch



NEW SLOPE FUNCTION

Optivision® Red Vial

- Highly visible red bubble edge



Backlit Digital Display

- Reads upright even when inverted

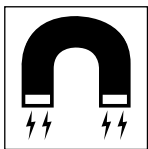

Rare Earth Magnets  
Finely Milled Surface



.0005 in/in Accuracy  
in all positions

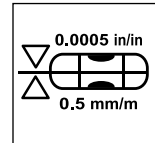

Solid Acrylic  
shockproof vials

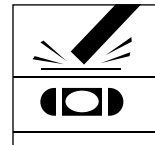

UV Resistant  
vials

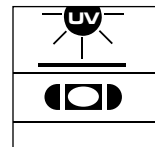

Lifetime Vial Warranty

- Solid acrylic vials are guaranteed not to fog, leak, or break



Large Shock Absorbing  
end cap

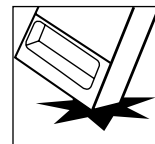

**NEW!**

## 905DG CONDOR Digital Levels

Part#	Length	Description
905DG-24	24"	Condor Digital Level w/ Case
905DG-48	48"	Condor Digital Level w/ Case
905DG-72	72"	Condor Digital Level w/ Case

# DIGITAL Levels

## 985D DIGIMAN®

- 2 Solid acrylic vials, including:
  - 1 - Plumb Site® Dual View™
  - 1 - Horizontal vial
- Digital accuracy: <math><0.1^\circ</math> at level and plumb, <math><0.2^\circ</math> at other angles
- 45° Tilted LCD display with backlight
- 180° Readout - Readable when level is inverted
- HOLD function for transferring measurements
- MODE function (Degree/Percentage/Pitch)
- Recalibration function and 'False Zero'
- Memory recall - 9 measurements
- Buzzer at 0°, 45°, 90°
- Large silicone buttons, easy to use while wearing gloves
- Shockproof end caps
- Finely milled surfaces
- Battery indicator
- 9V Battery included
- Water resistant padded case with accessory pouch (models 985D-24B, 985D-48B)
- Magnetic (models 985D-24B, 985D-48B, 985DL-24MB-D)
- Laser pointer (model 985DL-24MB-D)



Part#	Length	Description
985D-10	10"	DIGIMAN Level
985DL-24MB-D	24"	DIGIMAN Level, w/Laser Point; Mag.

Part#	Length	Description
985D-24B	24"	DIGIMAN Level, w/Bag; Magnetic
985D-48B	48"	DIGIMAN Level, w/Bag; Magnetic

## 393 DIGI-PRO Digital Angle Finder

- Digital accuracy:
  - <math><0.1^\circ</math> at level and plumb
  - <math><0.2^\circ</math> at other angles
- LCD display with backlight flips when inverted
- "False zero" measurements
- Magnetic base
- IP54 Dust & Water resistance rating
- Compact and user friendly

**NEW!**



Part#	Length	Description
393	2.3"	Digital Angle Finder

## 992 Digital Bevel

- Adjustable blade locks at any angle
- Digital display flips when inverted
- False zero, easy recalibration

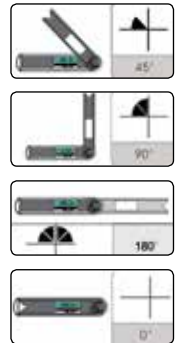

Part#	Length	Description
992	10"	Digital Bevel

# CONDOR™

with Optivision® Red & Plumb Site® Dual-View™ Vial



### Lifetime Vial Warranty

- Solid acrylic vials are guaranteed not to fog, leak, or break

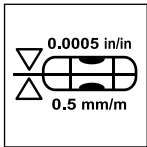

.0005 in/in Accuracy  
in all positions

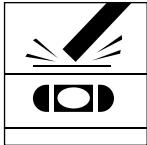

Solid Acrylic  
shockproof vials

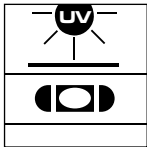

UV Resistant  
vials

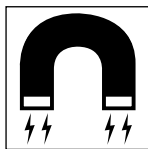

Magnetic Models Available



VPA Certified  
Vial accuracy certified  
by VPA laboratory

Precision Milled  
measuring surfaces  
(up to 48" models)



### Plumb Site® Dual View™

- Unique front view of vertical vial



### Optivision® Red Vial

- Highly visible red bubble edge

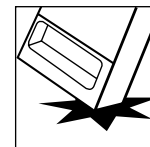

Large Shock Absorbing  
end cap

## 905 CONDOR™ BOX Levels



### OPTIVISION® A New Level of Visibility

**OPTIVISION®** is a Kapro invention that creates the effect of **strong color definition around the spirit level's horizontal bubble**, in stark contrast to the white vial background and clear liquid. The color contrast makes the bubble edges significantly easier to see, for fast and accurate placement between the vial's reading lines.

- **Highly visible red** bubble edge
- **Fast** placement between reading lines
- **Easy** viewing with tilted vial
- **Precise** leveling results

**VISIBLY BETTER**



### CONDOR™ Box Levels

Part#	Length	Description	Part#	Length	Description
905-41-24	24"	Condor Box Level	905-41-24M	24"	Condor Box Level; <i>Magnetic</i>
905-41-48	48"	Condor Box Level	905-41-48M	48"	Condor Box Level; <i>Magnetic</i>
905-41-72	72"	Condor Box Level	905-41-72M	72"	Condor Box Level; <i>Magnetic</i>

# APOLLO™

with Magnified Vial & Plumb Site® Dual-View™ Vial



### Plumb Site® Dual View™

- Unique front view of vertical vial

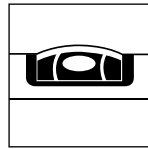

### Magnified Horizontal Vial

- 33% larger view for better readability

Precision Machined measuring surfaces (up to 48" models)



### Lifetime Vial Warranty

- Solid acrylic vials are guaranteed not to fog, leak, or break

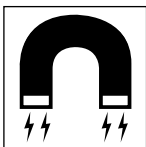

Magnetic Models Available



Large Shock Absorbing end cap

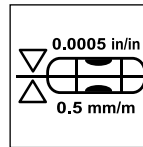
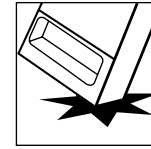

.0005 in/in Accuracy in all positions

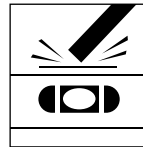

Solid Acrylic shockproof vials

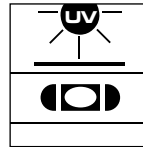

UV Resistant vials

Comfortable, Ergonomic hand holds



VPA Certified

- Vial accuracy certified by VPA laboratory



Shower/Bath Set

Door Jamb Set



## 985 APOLLO™ BOX Levels

### APOLLO™ - Individual Levels

Part#	Length	Description
985-41X-24	24"	Apollo Box Level
985-41X-32	32"	Apollo Box Level
985-41X-36	36"	Apollo Box Level
985-41X-48	48"	Apollo Box Level
985-41X-72	72"	Apollo Box Level
985-41X-78	78"	Apollo Box Level
985-41X-96	96"	Apollo Box Level

### APOLLO™ Magnetic - Individual Levels

Part#	Length	Description
985-41X-24M	24"	Apollo Box Level; <i>Magnetic</i>
985-41X-32M	32"	Apollo Box Level; <i>Magnetic</i>
985-41X-48M	48"	Apollo Box Level; <i>Magnetic</i>
985-41X-72M	72"	Apollo Box Level; <i>Magnetic</i>
985-41X-78M	78"	Apollo Box Level; <i>Magnetic</i>
985-41X-96M	96"	Apollo Box Level; <i>Magnetic</i>

### Level Sets - No Carrying Case

Part#	Length	Description
985-X-JMB	32" & 78"	Door Jamb Set - No Case 2 - 985 Apollo Box Levels
985M-X-JMB	32" & 78"	Magnetic Door Jamb Set - No Case 2 - 985 Apollo Box Levels; <i>Mag.</i>

### Level Sets - With Carrying Case

Part#	Length	Description
985B-X-JMB	32" & 78"	Door Jamb Set - With Case 2 - 985 Apollo Box Levels Carrying Case
985MB-X-JMB	32" & 78"	Magnetic Door Jamb Set - With Case 2 - 985 Apollo Box Levels; <i>Mag.</i> Carrying Case
985B-X-SBK	32" & 58"	Shower/Bath Set - With Case 2 - 985 Apollo Box Levels Carrying Case

### Boxed Level Sets - No Carrying Case

Part#	Length	Description
985-78-BXS		7 pc. <b>Boxed Master Set:</b>
	4"	246M Handy Level; <i>Magnetic</i>
	10"	923 Torpedo Level; <i>Magnetic</i>
	12"	779 Spirit Level
	24", 32" 48", 78"	4 - 985 Apollo Box Levels

Part#	Length	Description
985M-78-BXS		7 pc. <b>Magnetic Boxed Master Set:</b>
	4"	246M Handy Level; <i>Magnetic</i>
	10"	923 Torpedo Level; <i>Magnetic</i>
	12"	779 Spirit Level
	24", 32" 48", 78"	4 - 985 Apollo Box Levels; <i>Magnetic</i>

Carpenter's Set



### Specialty Boxed Level Sets - With Carrying Case

Part#	Length	Description
985-48-CBS		6 pc. <b>Carpenter's Set:</b>
	4"	246M Handy Level; <i>Magnetic</i>
	10"	923 Torpedo Level; <i>Magnetic</i>
	32"	770 Exodus Box Level
	24", 48"	2 - 985 Apollo Box Levels Multi-Level Carrying Case
985-48-HBS		5 pc. <b>Handyman's Set:</b>
	9"	227 Toolbox Level; <i>Mag.</i>
	24"	159 I-Beam Level; <i>Mag.</i>
	32"	770 Exodus Box Level
	48"	985 Apollo Box Level Multi-Level Carrying Case

Part#	Length	Description
985M-48-TBS		6 pc. <b>Tradesman's Set:</b>
	4"	246M Handy Level; <i>Magnetic</i>
	9"	925M Tradesman Level; <i>Mag.</i>
	12"	779 Spirit Level
	24"	170 Samson I-Beam Level; <i>Mag.</i>
	48"	985 Apollo Box Level; <i>Magnetic</i> Multi-Level Carrying Case
985T-48-MBS		5 pc. <b>Mason's Set:</b>
	10"	724 Cast Toolbox Level
	32"	930 Smartcast Mason's Level
	24", 48"	2 - 985T Titan Mason's Box Levels Multi-Level Carrying Case

## BOX Levels

### 770 EXODUS™ Box Levels with Straight Edge Ruler

- Solid acrylic epoxy locked vials, including: Horizontal with gradient lines up to 2%, vertical, and 45°
- Precise straight edge ruler along top profile
- Shock absorbing end caps



Part#	Length	Description	Part#	Length	Description
770-42-32	32"	Exodus Box Level	770-42-48	48"	Exodus Box Level

### 779 SPIRIT™ Level

- Solid acrylic epoxy locked vials
- Shock absorbing end caps and wall grip feature
- Finely milled surface



**NEW!**

Part#	Length	Description
779-42-12	12"	Spirit Mini Box Beam Level

### 781 GENESIS™ Box Levels with Plumb Site® Dual-View™ Vial

- Solid acrylic epoxy locked vials, including: Plumb Site® Dual View™ vertical vial and horizontal vial with gradient lines up to 2%
- Finely milled surface up to 48"
- Shock absorbing rubber end caps with wall grip feature

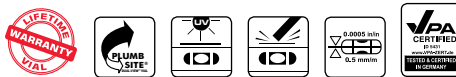

Part#	Length	Description	Part#	Length	Description
781-41P-24	24"	Genesis Box Level	781-41P-48	48"	Genesis Box Level
781-41P-36	36"	Genesis Box Level	781-44P-72	72"	Genesis Box Level

### 995 VULCAN™ Box Levels with Magnified Vial & Plumb Site® Dual-View™ Vial

- 3 Solid acrylic epoxy locked vials, including: Plumb Site® Dual View™ vertical vial and magnified horizontal vial
- 2 Finely milled surfaces with V-groove base up to 48"
- Rubber shockproof end caps



Part#	Length	Description	Part#	Length	Description
995-41X-24	24"	Vulcan Box Level	995-41X-24M	24"	Vulcan Box Level; <i>Magnetic</i>
995-41X-36	36"	Vulcan Box Level	995-41X-32M	32"	Vulcan Box Level; <i>Magnetic</i>
995-41X-48	48"	Vulcan Box Level	995-41X-48M	48"	Vulcan Box Level; <i>Magnetic</i>
995-41X-72	72"	Vulcan Box Level	995-41X-72M	72"	Vulcan Box Level; <i>Magnetic</i>
995-41X-96	96"	Vulcan Box Level	995-41X-78M	78"	Vulcan Box Level; <i>Magnetic</i>
			995-41X-96M	96"	Vulcan Box Level; <i>Magnetic</i>

## I-BEAM Levels and Carrying Cases

### 130 PROJECT I-Beam Levels

- 3 Easy to read vials, including: horizontal, vertical, and 45°
- V-groove base for pipe/conduit
- Tough ABS end caps
- Comfortable hand grip



Part#	Length	Description
130-62-24	24"	Project I-Beam Level

Part#	Length	Description
130-62-48	48"	Project I-Beam Level

### 150 I-Beam Levels with Plumb Site®

- 3 Cylindrical vials, including:
- 1 Plumb Site® Dual View™ vertical vial, and horizontal vials
- Sturdy aluminum frame with V-groove base for pipe/conduit
- Shock absorbing rubber end caps
- Handle
- Magnetic models available



Part#	Length	Description
150-81-24	24"	I-Beam Level
150-81-36	36"	I-Beam Level
150-81-48	48"	I-Beam Level
150-81-72	72"	I-Beam Level

Part#	Length	Description
159-81-24	24"	I-Beam Level; <i>Magnetic</i>
159-81-48	48"	I-Beam Level; <i>Magnetic</i>

### 170 SAMSON™ I-Beam Levels with Plumb Site®

- 3 Cylindrical vials, including: 1 Plumb Site® Dual View™ vertical vial, horizontal vials, (45° vial model available)
- Heavy duty aluminum frame with finely milled surface up to 48"
- Shock absorbing rubber end caps
- Ergonomic rubber handle
- Magnetic models available

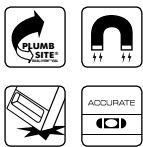

Part#	Length	Description
170-81-24	24"	Samson I-Beam Level
170-81-48	48"	Samson I-Beam Level
170-81-72	72"	Samson I-Beam Level

Part#	Length	Description
170-81-24M	24"	Samson I-Beam Level; <i>Magnetic</i>
170-81-48M	48"	Samson I-Beam Level; <i>Magnetic</i>
170-82-24	24"	Samson I-Beam with 45° Angle Vial

### Carrying Cases



Part#	Length	Description
CASE-24	24"	Nylon Carrying Case
CASE-48	48"	Nylon Carrying Case

Part#	Length	Description
BAG-JMB	78"	Door Jamb Case-Fits 78" & 32"
BAG-3L1T	Up to 48"	Multi-Level Bag

## MASONRY Levels

**Levels for masonry use must be built tough - designed to withstand repeated trowel and hammer blows, drops, and harsh conditions - and still maintain their accuracy.**

Kapro has a range of levels that do just that. Our SUPERCAS<sup>TM</sup>, SHARK<sup>®</sup>, and SMARTCAS<sup>TM</sup> levels offer the strength of cast aluminum bodies, rugged strike pads, and exceptional accuracy from our solid acrylic epoxy locked vials. We also offer TITAN<sup>TM</sup> Mason's levels, TOPGRADE<sup>TM</sup> Gradient levels, and Bamboo wood levels for masonry.

### 105 TOPGRADE<sup>TM</sup> Gradient Levels with Slope Measurement

- Solid acrylic vials, including:
  - 3 to 5 Horizontal vials (depending on length of level)
  - 1 Vertical vial
- Accurate slope measurement at up to 2%
- Finely milled surface up to 48"
- Magnetic models available



Part#	Length	Description
105-24	24"	Topgrade Gradient Level
105-48	48"	Topgrade Gradient Level

Part#	Length	Description
105-24M	24"	Topgrade Level; <i>Magnetic</i>
105-48M	48"	Topgrade Level; <i>Magnetic</i>

### 121 Bamboo Levels

- Durable bamboo, reinforced with heavy duty extruded aluminum frame
- Solid acrylic vials - individually calibrated to 0.00075 in/in for maximum accuracy
- Impact resistant, UV, and fogging protected vials
- Improved shock absorbing cast rubber end caps
- Laminated for extra dimensional stability and easy cleaning



Part#	Length	Description
121-41-48	48"	Bamboo Wood Level

### 985T TITAN<sup>TM</sup> Levels

- 3 Solid acrylic epoxy locked vials, including:
  - 1 Magnified horizontal vial
  - 2 vertical vials
- Integrated rubber strike pad to absorb blows from trowels and hammers
- Cushioned shock absorbing end caps

**NEW!**



Part#	Length	Description
985T-41X-24	24"	Titan Mason's Level

Part#	Length	Description
985T-41X-48	48"	Titan Mason's Level

# MASONRY Levels

## 720 SUPERCAST™ Levels

- 2 Solid acrylic vials: horizontal and vertical
- Heavy duty cast aluminum trapezoidal (tapered) body
- Finely milled surface
- Accuracy of <0.0005 in/in



Part#	Length	Description	Part#	Length	Description
720-10-16	16"	Supercast Mason Level	720-10-24	24"	Supercast Mason Level

## 920 SHARK® Levels

with Plumb Site® Dual View™

- Solid acrylic vials, including:
  - 1 Plumb Site® Dual View™ vertical vial
  - Horizontal vial with gradient lines up to 2%
- 2 Shock absorbing rubber strike pads
- Finely milled surface
- Accuracy of <0.0005 in/in



Part#	Length	Description	Part#	Length	Description
920-10-24	24"	Shark Mason Level	920-10-32	32"	Shark Mason Level

## 930 SMARTCAST™ Levels

with Optivision®

- 2 Solid acrylic vials, including:
  - Optivision® Red horizontal vial with highly visible red bubble edges
  - 1 Vertical vial
- Horizontal vial has gradient lines for slope measurement up to 2% and is tilted for easy reading and direct line of sight
- Heavy duty cast aluminum trapezoidal (tapered) body with bridge at horizontal vial for increased strength
- Shock absorbing rubber strike pads and end caps
- Finely milled surface
- Accuracy of <0.0005 in/in



Part#	Length	Description	Part#	Length	Description
930-16	16"	Smartcast Mason Level	930-32	32"	Smartcast Mason Level
930-24	24"	Smartcast Mason Level			

## TORPEDO Levels

### 227 Toolbox Level

- 3 Cylindrical vials, including: horizontal, vertical, and 45°
- V-groove for pipes/conduit
- Magnetic base
- Rubber end caps



Part#	Length	Description
227-08	9"	Toolbox Level; <i>Magnetic</i>
227-08D	9"	Toolbox Level; <i>Mag.</i> ; 20 pc. Display

### 724 Cast Level

- 2 solid acrylic shockproof vials, including: horizontal & vertical
- Accuracy: <0.0005 in/in
- Milled surface
- Cast aluminum body



Part#	Length	Description
724	10"	Cast Toolbox Level
724-D	10"	Cast Level in 12 pc. Display
724M	10"	Cast Level; <i>Magnetic</i>

### 925M TOPCLASS™ Tradesman Level

- Anodized coated with anti-corrosion protection
- Epoxy locked vials x 4
- Plumb Site® vertical vial
- Horizontal vial, 45° vial, 30° vial
- Extra strong rare-earth magnets
- V-groove for pipes
- Ruler and Hanging strap



Part#	Length	Description
925M	9"	Tradesman Level; <i>Magnetic</i>

### 923 Cast Level

- 3 Solid acrylic vials, including: -Plumb Site® Dual View™ vial
- -Epoxy locked horizontal vial
- -45° Angle vial
- Accuracy: <0.0005 in/in
- Milled surface with rare-earth magnets
- Heavy-duty cast aluminum body
- V-groove for pipes/conduit

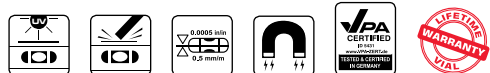

Part#	Length	Description
923-10-10	10"	Cast Toolbox Level; <i>Magnetic</i>

### 935 OPTIVISION® Red Torpedo Level

- Solid acrylic shockproof vials including: Optivision® Red horizontal vial with gradient lines up to 2%
- Tilted horizontal epoxy locked vial for direct line of sight view
- Angle Finder with gradient markings every 7.5°
- Rare-earth magnets
- Finely milled surface with V-groove for pipe/conduit
- Shock absorbing end caps



Part#	Length	Description
935-10	10"	Cast Optivision® Level; <i>Magnetic</i>

# TORPEDO & SPECIALTY Levels

## 229 Toolbox Level

- 3 Cylindrical vials, including: horizontal, vertical, and 45°
- V-groove for pipes/conduit
- Magnetic base



Part#	Length	Description
229-32-B	9"	Toolbox Level; <i>Magnetic</i>

## 929 Toolbox Level with Plumb Site®

- 3 Cylindrical vials, including: horizontal, vertical, and 45°
- Magnetic V-groove for pipes/conduit
- Leveling ledge for tiles/sills
- Sturdy aluminum frame and base



Part#	Length	Description
929	10"	Toolbox Level; <i>Magnetic</i>

## 240 Bull's Eye Level

- Multipurpose surface level
- Pre-cast holes for easy attachment
- Sensitivity: 30arc/min.



Part#	Description
240-01	Bull's Eye Surface Level

## 242 Cross Level

- Multipurpose surface level
- 2 Cylindrical vials
- Pre-cast holes for easy attachment
- Magnetic
- Sensitivity: 30arc/min.



Part#	Description
242-08	Cross Surface Level; <i>Magnetic</i>

## 245 Mini Level

- 2 Easy to read vials
- Angle Finder with patented Top-scroll adjustment
- Strong molded plastic casing
- Pocket size - 4" length



Part#	Description
245-9	Mini Level with Angle Finder

## 246 Handy Level

- Shockproof solid acrylic vial
- Lightweight aluminum box profile with shock absorbing end caps
- Pocket size - 4" length



Part#	Description
246	Handy Level
246-D	Handy Level; 10 pc. Display
246M	Handy Level; <i>Magnetic</i>
246M-D	Handy Level; <i>Mag.</i> ; 10 pc. Display

## 846 CYCLOPS™ Cast Level

- Plumb Site® Dual View™ vial
- Durable cast aluminum body
- 2 finely milled surfaces with V-groove
- Rare-earth magnets
- Pocket size - 4" length



Part#	Description
846	Cyclops Pocket Cast Level; <i>Magnetic</i>

## 946 SMARTY™ Level

- Optivision® Red vial with gradient lines
- Durable cast aluminum body with hand grips
- Rare-earth magnets
- Clip belt housing
- Precision: 0.0005 in/in
- Pocket size - 4" length



Part#	Description
946M	Smarty Level; <i>Magnetic</i>
946M-D	Smarty Level; <i>Mag.</i> ; 6 pc. Display

## SPECIALTY

### 340 POSTRITE® Folding Post Level

- 3 Vials
- Folds closed, opens flat
- Click-lock every 15°
- 4 Magnets
- Adjustable strap



Part#	Description
<b>340-08D</b>	<b>Postrite Post Level; Magnetic in 6 pc. Display</b>

### 350 Pipe Level - 5 Piece Set

- For plastic and metal pipe sizes (see table)
- 2 Easy to read vials - vertical and horizontal



Nominal Sizes	IPS Steel	CTS Copper	PP Plastic
	Stainless Steel PVC Plastic Inches / mm	Inches / mm	Inches / mm
<b>1/2"</b>	1/2 <span style="color: red;">15</span>	3/4 <span style="color: red;">20</span>	<span style="color: red;">25</span>
<b>3/4"</b>	3/4 <span style="color: red;">20</span>	1 <span style="color: red;">25</span>	<span style="color: red;">32</span>
<b>1"</b>	1 <span style="color: red;">25</span>	1 1/4-1 1/2 <span style="color: red;">32-40</span>	<span style="color: red;">40</span>
<b>1 1/4"</b> <b>- 1 1/2"</b>	1 1/4-1 1/2 <span style="color: red;">32-40</span>	-	<span style="color: red;">50</span>
<b>2"</b>	2 <span style="color: red;">50</span>	-	<span style="color: red;">63</span>

Part#	Description
<b>350</b>	<b>Pipe Level Set - 5 Sizes</b>

### 341 Mini Post Level

- 3 Vials
- Adjustable elastic strap for non-magnetic surfaces
- 4 Powerful magnets for magnetic surfaces
- For use with all posts, pipes, and signs



Part#	Description
<b>341</b>	<b>Mini Post Level; Magnetic</b>
<b>341-D</b>	<b>Mini Post Level 12 pc. Display</b>

### 301 T-Bevel



- Stainless steel blade
- 3/4" (5mm) Trim gauge on side and bottom

Part#	Length	Description
<b>301-01</b>	<b>7"</b>	<b>T-Bevel</b>



## DRYWALL T-SQUARES

### 316 Drywall T-Square

- Anodized aluminum finish
- Double edge and angular marking
- Certified 90°
- Angle markings 15°, 20°, 22.5°, 30°, 45°, 60°, 70°, 75°, 80°
- For cutting all types of drywall or sheet materials

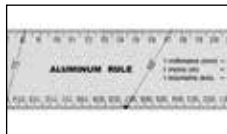
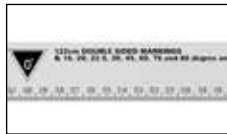

Part#	Length	Description
316-48-T	48"	Drywall T-Square

### 317 Adustable Drywall T-Square

- Anodized aluminum finish
- Sliding head adjusts to any angle
- Folds for easy storage
- ABS end caps with ledge
- Double edge heavy duty blade
- Durable printed scale
- Etched angle markings
- Strong screw lock

LEDGE FOR HANDS FREE HOLD

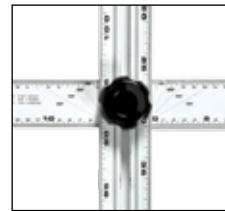
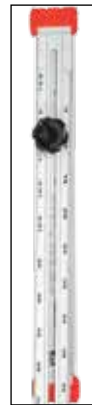

Part#	Length	Description
317-48-A	48"	Adjustable Drywall T-Square

## COMBINATION SQUARES

### 325M Magnetic Combo Square

- Strong magnetic lock - no screws
- Stainless steel ruler
- Heavy-duty cast zinc head with vial
- Etched markings

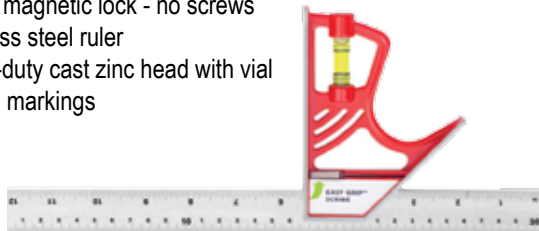

Part#	Length	Description
325M	12"	Magnetic Combination Square

### 352 Locking Combination Square

- Heavy duty cast zinc head with vial
- Stainless steel ruler locks in place with screw
- Etched markings

NEW!



Part#	Length	Description
352-12	12"	Lock Combination Square

**NEW SQUARES**

**353 LEDGE-IT™ SQUARES**

**NEW!**

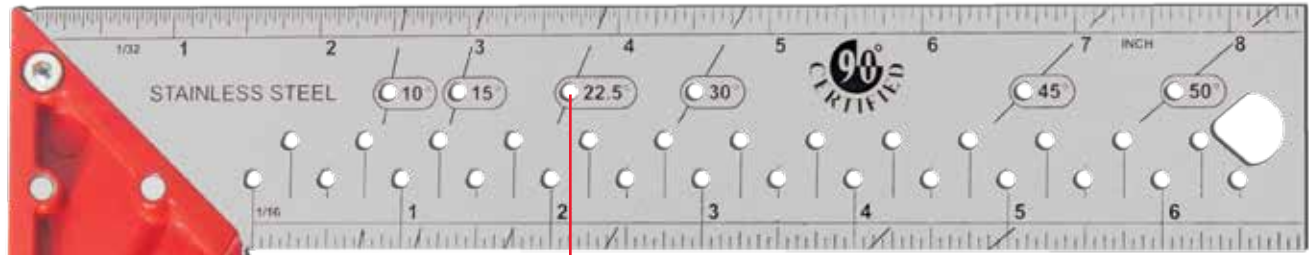

**Stainless Steel Ruler**

- Permanently etched ruler markings
- Etchings and holes for beveling and framing at: 10°, 15°, 22.5°, 30°, 45°, 50°, and 60°

**Certified 90° Angle**



**2-Sided Cast Aluminum Handle**

- 30° Cast-in Platform

**Marking Groove on Handle**

**Milled Surfaces**



**Retractable Metal Ledge Support**

- Stabilizes the square on any surface

<b>353 LEDGE-IT™ Square</b>		
Part#	Length	Description
353-08	8"	Ledge-It Square
353-10	10"	Ledge-It Square
353-12	12"	Ledge-It Square

# SQUARES AND RULERS

## 305 Framing Square

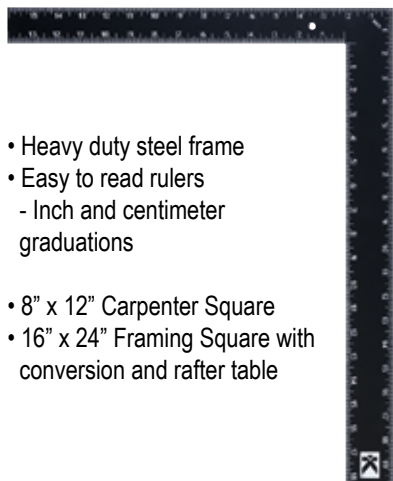

- Heavy duty steel frame
- Easy to read rulers
  - Inch and centimeter graduations
- 8" x 12" Carpenter Square
- 16" x 24" Framing Square with conversion and rafter table

Part#	Length	Description
305-12	12"	Steel Framing Square
305-24	24"	Steel Framing Square

## 306 Ruler



- Anodized aluminum ruler
- Durable printing
- Wear resistant UV cured screen printing
- Printed scale accurate to 0.0007in/in
- English/Metric graduations with conversion tables
- 1.2" width

Part#	Length	Description
306-12	12"	Aluminum Ruler
306-36	36"	Aluminum Ruler

## 308 Straight Edge



- Contractor grade
- Anodized aluminum
- Wear resistant UV cured screen printing
- Printed scale accurate to 0.0007in/in
- English graduations
- 2" width

Part#	Length	Description
308-24	24"	Aluminum Straight Edge
308-48	48"	Aluminum Straight Edge

## 302 Stair Gauge

- Solid brass construction
- For use with framing square
- For stair layout and any other repeat marking

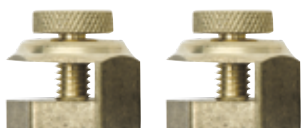

Part#	Description
302-01	Brass Stair Gauges

## 444 Rafter Square

- Durable and lightweight Ergocast™ material
- Molded-in conversion tables
- Easy to read graduations
- Base enables easy marking and cutting



Part#	Description
444-00	7" Ergocast™ Rafter Square

## 445 Rafter Square

- Durable diecast aluminum
- Etched conversion tables
- Easy to read graduations
- Base enables easy marking and cutting



Part#	Description
445-7	7" Diecast Rafter Square
445-12	12" Diecast Rafter Square

## 309 LEDGEND™ Square



- Unique support ledge for hands-free hold
- Certified 90° angle
- Stainless steel blade

Part#	Length	Description
309-08	8"	Ledgend Square
309-12	12"	Ledgend Square

## WHY KAPRO LASERS?

For 30 years, Kapro has been making the finest quality spirit levels, laser levels, layout tools, marking and measuring tools. We have built a reputation as the industry's foremost innovator, and we are renowned for our quality products, outstanding service, added value, and cutting-edge designs.

Kapro owns and operates state-of-the-art facilities in Israel, North America, and Asia. Its manufacturing facilities are certified compliant with ISO standards 9001, 14001, and SA8000. Since Kapro owns and operates all of its own laser facilities that allows us to bring you better quality, features and accuracy than our competitors at a value price. This keeps more money in your pocket while providing a best-in-class user experience.

With a total of 9 models to choose from, we have one of the best assortments of green beam lasers in the world. So, whether you are a remodeler, framer, concrete specialist, tile installer or electrician - we have a model that will make your work faster, cleaner, and more accurate.

### 9 GREEN BEAM / DOT MODELS

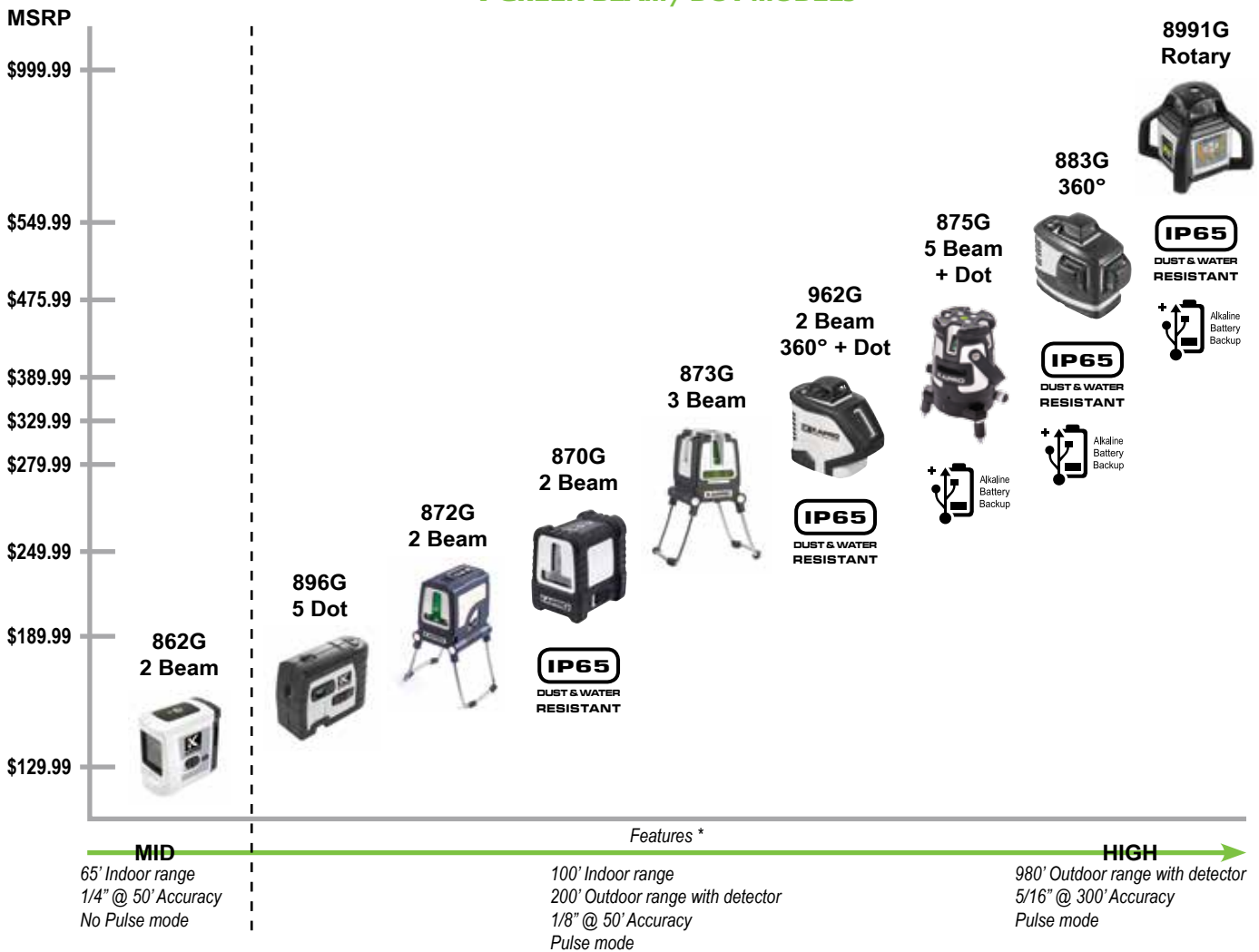

\* Check specific model page for exact specifications

## WHY KAPRO LASERS?



Model:  
862G

- Over the counter exchange
- Less downtime



Models:

- 870G, 872G, 873G, 875G  
896G, 883G, 962G, 8991G
- Over the counter exchange
  - Less downtime



**DUST & WATER RESISTANT**

Models:

- 870G, 883G,  
962G, 8991G
- Best for outdoor applications



All Models:

- Superior laser diodes
- Lasts > 30,000 hours

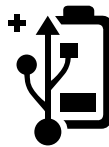

Alkaline  
Battery  
Backup

Models:

- 875G, 883G, 8991G
- Rechargeable batteries included
  - Alkaline battery back-up

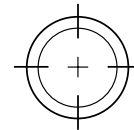

Accuracy:

- 1/4" @ 50' 862G
- 3/16" @ 50' 896G, 962G
- 1/8" @ 50' 870G, 872G, 873G  
875G, 883G
- 5/16" @ 300' 8991G

### KAPRO Laser Models & Applications

APPLICATION	896G 5 Dot	862G 2 Beam	870G 2 Beam-IP65	872G 2 Beam	873G 3 Beam	875G 5 Beam	962G 360° 2 Beam-IP65	883G 360° 3 Beam-IP65	8991G Rotary-IP65
Excavation								IP65	IP65
Deck & Railing			IP65				IP65	IP65	IP65
Drop Ceilings									
Finish Carpentry & Drywall									
Forms & Foundations							IP65	IP65	IP65
Framing							IP65	IP65	IP65
Glass Work									
Mechanical (PLB, ELE, HVAC)							IP65	IP65	IP65
Painting			IP65				IP65	IP65	
Remodeling			IP65				IP65	IP65	
Tile & Flooring			IP65				IP65	IP65	

# 896G PROLASER® DOT - GREEN

Battery Cover

**NEW!**



Laser Beam Output Pattern:

- Horizontal center dot
- Right 90° dot, Left 90° dot
- Plumb up and Plumb down

Magnetic Mounts



## 5 Dot Self-Leveling Laser with Multi-function Base

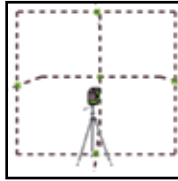

**INDOOR  
OUTDOOR  
AND  
TILT MODE**

Specifications	
Laser type	Dot
Dot beams	Horizontal center, Right 90°, Left 90°, Plumb Up & Plumb Down
Indoor laser range	65ft. (20m)
Outdoor laser range (with detector)	165ft (50m)
Self-leveling range	±3.5°
Accuracy	3/16" @ 50ft (0.3mm/m)
Wavelength	510 ±10nm - Laser Class II
Power Supply	2 AA batteries (included)
Dust & Water Resistance	IP54
Tripod ready*	1/4"
Dimensions	4.5" x 3.5" x 1.8"

\*1/4" and 5/8" tripod ready with multi-function base

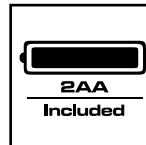

**Includes:**  
**Laser unit, 2 AA batteries, Laser target, Soft case, and Multi-function base**

# 862G PROLASER® - GREEN



Laser Beam Output Pattern:  
• Horizontal and Vertical cross lines





## 2 Beam Self-Leveling Laser

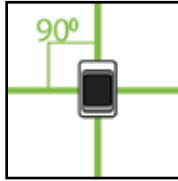

**INDOOR  
AND  
TILT MODE**

Specifications	
Horizontal beam	1
Vertical beam	1
Cross beam	1
Indoor laser range	65ft. (20m)
Self-leveling range	±3°
Manual locking mode for angle layout & marking	✓
Accuracy	1/4" @ 50ft (0.4mm/m)
Wavelength	520 ±10nm - Laser Class II
Power Supply	2 AA batteries (included)
Dust & Water Resistance	IP54
Tripod ready	1/4"
Dimensions	3.5" x 2.2" x 3.6"

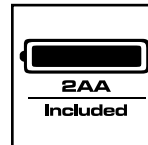

**Includes:**  
**Laser unit, 2 AA batteries, Soft case, and Velcro mounting strap**

# 870G VHX PROLASER® - GREEN

Manual Mode



Beam Selector



Pulse/Outdoor Mode



**IP65**

DUST & WATER  
RESISTANT

Keypad

Shock Resistant  
Rubber Casing



Laser Beam Output Pattern:

- Horizontal and Vertical cross lines
- Horizontal line
- Vertical line

On/Off Switch



## 2 Beam Self-Leveling Laser with IP65 Weather Protection

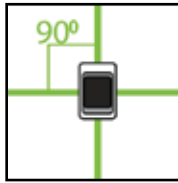

**INDOOR  
OUTDOOR  
AND  
TILT MODE**

Specifications	
Horizontal beam	1
Vertical beam	1
Cross beam	1
Indoor laser range	100ft. (30m)
Outdoor laser range (with detector)	200ft. (60m)
Self-leveling range	±3°
Manual locking mode for angle layout & marking	✓
Accuracy	1/8" @ 50ft (0.2mm/m)
Wavelength	525 ±5nm - Laser Class II
Power Supply	3 AA batteries (included)
Dust & Water Resistance	IP65
Tripod ready*	1/4"
Dimensions	3.9" x 3.5" x 2.8"

\*Comes with 5/8" adapter

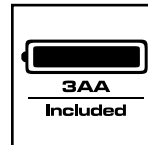

**Includes:**  
Laser unit, 3 AA batteries, Deluxe padded soft case, Laser target, and Magnetic mounting bracket

# 872G PROLASER® - GREEN

Manual Mode



Beam Selector

Pulse/Outdoor Mode

Laser Beam Output Pattern:

- Horizontal and Vertical cross lines
- Horizontal line
- Vertical line



Strong Folding Legs for Angle Mounting and Height Adjustment



## 2 Beam Self-Leveling Laser with Folding Legs



**INDOOR  
OUTDOOR  
AND  
TILT MODE**

Specifications	
Horizontal beam	1
Vertical beam	1
Cross beam	1
Indoor laser range	100ft. (30m)
Outdoor laser range (with detector)	200ft. (60m)
Self-leveling range	±3°
Manual locking mode for angle layout & marking	✓
Accuracy	1/8" @ 50ft (0.2mm/m)
Wavelength	520 ±10nm - Laser Class II
Power Supply	3 AA batteries (included)
Dust & Water Resistance	IP54
Tripod ready*	1/4"
Dimensions	3.9" x 3.2" x 4.1"

\*Comes with 5/8" adapter

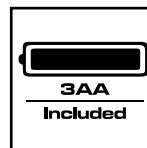

**Includes:**  
Laser unit, 3 AA batteries, Soft case, and 5/8" Tripod adapter

# 873G PROLASER® - GREEN



Manual Mode

Beam Selector

Pulse/Outdoor Mode



Laser Beam Output Pattern:

- Horizontal and 2 orthogonal vertical cross beams
- Horizontal and forward vertical cross beams
- Forward vertical beam
- Forward and side orthogonal vertical beams



Anti-slip Grips



## 3 Beam Self-Leveling Laser with Folding Legs



**INDOOR  
OUTDOOR  
AND  
TILT MODE**

Specifications	
Horizontal beam	1
Vertical beams	2
Cross beams	3
Indoor laser range	100ft. (30m)
Outdoor laser range (with detector)	200ft. (60m)
Self-leveling range	±3°
Manual locking mode for angle layout & marking	✓
Accuracy	1/8" @ 50ft (0.2mm/m)
Wavelength	520 ±10nm - Laser Class II
Power Supply	3 AA batteries (included)
Dust & Water Resistance	IP54
Tripod ready*	1/4"
Dimensions	4.2" x 3.5" x 4"

\*Comes with 5/8" adapter

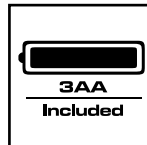

**Includes:**  
Laser unit, 3 AA batteries, Soft case, and 5/8" Tripod adapter

# 875G PROLASER® - GREEN



- Laser Beam Output Pattern:
- Horizontal and forward vertical cross beams
  - Horizontal, forward and backward vertical cross beams
  - Horizontal and 4 orthogonal vertical beams
  - Horizontal beam

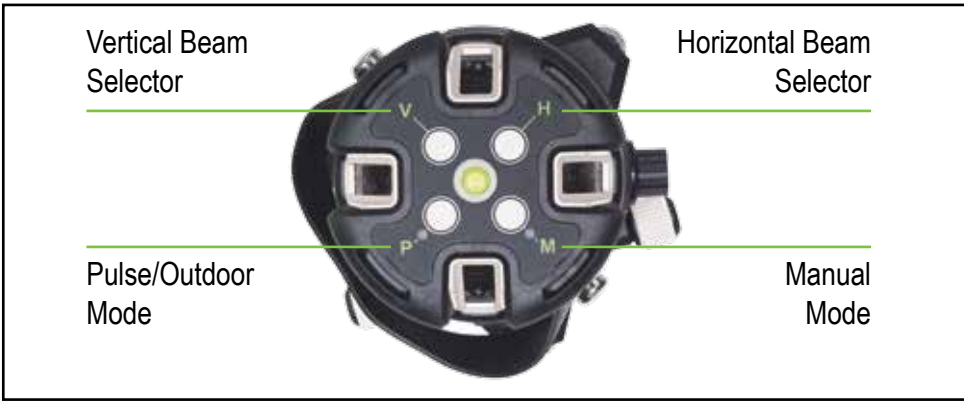



## 5 Beam Self-Leveling Laser with Plumb Dot

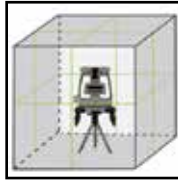

**INDOOR  
OUTDOOR  
AND  
TILT MODE**

Specifications	
Horizontal beam	1
Vertical beams	4
Plumb dot	On ground & crosshair on ceiling
Indoor laser range	100ft. (30m)
Outdoor laser range (with detector)	200ft. (60m)
Self-leveling range	±2.5°
Manual locking mode for angle layout & marking	✓
Accuracy	1/8" @ 50ft (0.2mm/m)
Wavelength	520 ±10nm - Laser Class II
Power Supply	Li-polymer batteries (included)
Dust & Water Resistance	IP54
Tripod ready*	5/8"
Dimensions	6" x 8"

\*Comes with tripod adapter

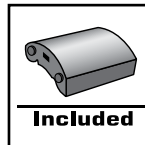

Li-Polymer battery x 2

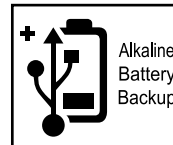

3 AA  
Not included



**Includes:**

**Laser unit, 2 Li-polymer rechargeable batteries, Battery charger, Laser target, Deluxe padded soft case, and Tripod adapter**

# 883G PROLASER® 3D- GREEN

**IP65**  
DUST & WATER  
RESISTANT



Multi-functional  
Mount

Beam/Battery  
Indicator



Pulse Mode  
Indicator

Beam Selector/  
Manual Mode

Pulse/Outdoor  
Mode

Laser Beam Output Pattern:

- Horizontal 360°
- Side vertical 360°
- Both verticals 360°
- Horizontal and verticals - all 360°



## 3 Beam 360° Self-Leveling Laser with IP65 Weather Protection

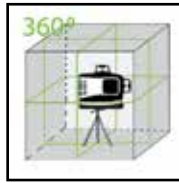

**INDOOR  
OUTDOOR  
AND  
TILT MODE**

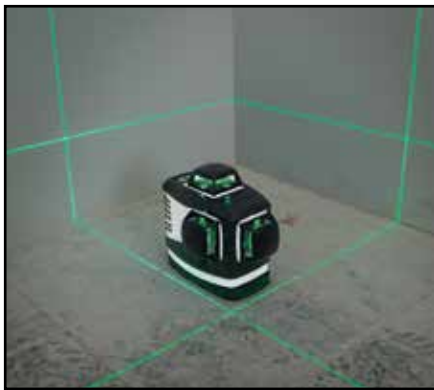

Specifications	
Horizontal beam	1 x 360°
Vertical beams	2 x 360°
Cross beams	6
Indoor laser range	100ft. (30m)
Outdoor laser range (with detector)	230ft. (70m)
Self-leveling range	±2.5°
Manual locking mode for angle layout & marking	✓
Accuracy	1/8" @ 50ft (0.2mm/m)
Wavelength	515-525nm - Laser Class II
Power Supply	Li-Ion battery (included)
Dust & Water Resistance	IP65
Tripod ready	1/4" & 5/8"
Dimensions	5.9" x 3.6" x 5.1"

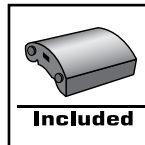

Li-Ion battery

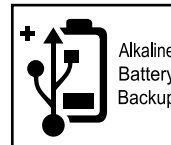

4 AA  
Not included



**Includes:**  
**Laser unit, Li-ion rechargeable battery, Hard case, Laser target, Beamfinder™ glasses, and Deluxe multi-function mount**

# 962G PROLASER® - GREEN

**NEW!**

**IP65**

**DUST & WATER  
RESISTANT**

Multi-functional  
Mount



Plumb Dot Down

Beam/Battery  
Indicator

Pulse Mode  
Indicator



Beam Selector/  
Manual Mode

Pulse/Outdoor  
Mode

Laser Beam Output Pattern:

- Horizontal 360°
- Front vertical
- Plumb up & Plumb down dots



## 2 Beam 360° + Cross Beam & Plumb Dot Self-Leveling Laser

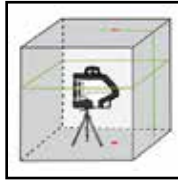

**INDOOR  
OUTDOOR  
AND  
TILT MODE**

Specifications	
Horizontal beam	1 - 360°
Vertical beam	1 - Cross
Dot beams	Plumb Up and Plumb Down
Indoor laser range	100ft. (30m)
Outdoor laser range (with detector)	200ft. (60m)
Self-leveling range	±3°
Manual locking mode for angle layout & marking	✓
Accuracy	3/16" @ 50ft (0.3mm/m)
Wavelength	515-525nm - Laser Class II
Power Supply	4 AA batteries (included)
Dust & Water Resistance	IP65
Tripod ready	1/4" & 5/8"
Dimensions	4.7" x 2.4" x 4.5"

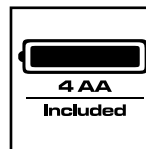

**Includes:**  
Laser unit, Multi-functional mount, Laser target, 4 AA batteries,  
and Deluxe hard case

# 8991G PROLASER® ROTARY- GREEN

**NEW!**

Plumb Dot - Up

**IP65**

**DUST & WATER RESISTANT**

Protective Shock-Absorbing Cover

Rotating Head

Carrying Handle

Control Panel



X/Y Axis Markings on top



Laser Detector and Remote Control included

Dual Tripod Mount Holes



1. Rotation left
2. Rotation right
3. Manual/Auto (in manual mode the self-leveling is disabled)
4. Power On/Off button
5. Automatic drift system
6. Rotation speed control
7. Direction scanning
8. Y axis controls
9. X axis controls

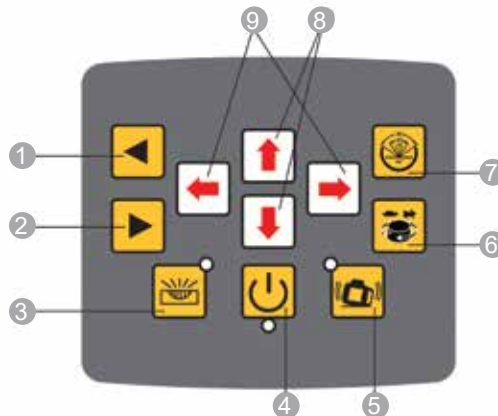

## Dual Slope Self-Leveling Rotary Laser with IP65 Weather Protection



**INDOOR  
OUTDOOR  
AND  
TILT MODE**

Specifications	
360° Rotating beams	Horizontal or Vertical
Dot beams	Plumb Up and Plumb Down
Slope setting	±5° (X & Y planes)
Indoor laser range	160ft. (50m)
Outdoor laser range (with detector)	980ft. (300m)
Self-leveling range	±5°
5 Variable speeds	0, 60, 120, 300, 600 rpm
Accuracy	5/16" @ 300ft (0.1mm/m)
Wavelength	635nm ±5nm - Laser Class II
Power Supply	Dual: Ni-MH battery / 4 C batteries (included)
Dust & Water Resistance	IP65
Tripod ready	5/8"
Dimensions	8" x 8" x 8.3"

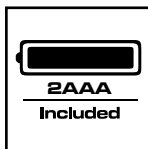
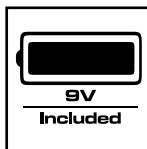
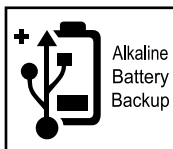

4 C  
Included

For laser  
detector

For remote  
control

**Includes:**  
**Laser unit with remote control, Laser detector with bracket,**  
**Rechargeable batteries, Battery charger, Alkaline battery module,**  
**Beamfinder™ glasses, and Deluxe hard case**

# 899R PROLASER® ROTARY- RED



<ol style="list-style-type: none"> <li>1. Power indicator</li> <li>2. Low battery indicator</li> <li>3. Manual mode indicator</li> <li>4. Power button</li> <li>5. Rotation speed control</li> <li>6. Scanning mode control</li> <li>7. Manual/Automatic mode</li> <li>8. Increase X axis slope control (manual mode only)</li> <li>9. Reduce X axis slope control (manual mode only)</li> <li>10. Increase Y axis slope control (manual mode only)</li> <li>11. Reduce Y axis slope control (manual mode only)</li> <li>12. Clockwise direction control (scan mode only)</li> <li>13. Counterclockwise direction control (scan mode only)</li> <li>14. Remote control sensor</li> </ol>	
--	--



## Dual Slope Self-Leveling Rotary Laser





**INDOOR  
OUTDOOR  
AND  
TILT MODE**

Specifications	
360° Rotating beams	Horizontal or Vertical
Dot beams	Plumb Up and Plumb Down
Slope setting	±5° (X & Y planes)
Indoor laser range	165ft. (50m)
Outdoor laser range (with detector)	800ft. (250m)
Self-leveling range	±5°
5 Variable speeds	0, 60, 120, 300, 600 rpm
Accuracy	1/8" @ 100ft (0.1mm/m)
Wavelength	635nm - Laser Class II
Power Supply	Ni-MH battery (included)
Dust & Water Resistance	IP54
Tripod ready	5/8"
Dimensions	5.5" x 5.5" x 7"



**Ni-MH**  
Battery  
Included

  
**9V**  
Not Included

  
**2AAA**  
Not Included

  
**THREE  
WARRANTY  
YEAR**

For laser  
detector

For remote  
control

**Includes:**

**Laser unit with remote control, Laser detector with bracket, Rechargeable battery, Battery charger, Beamfinder™ glasses, and Deluxe hard case**

# LASER ACCESSORIES



## Beamfinder™ Glasses

- Enhances visibility of laser beam
- Models available for Red or Green lasers



Part#	Description
840	Red Beamfinder™ Glasses
840G	Green Beamfinder™ Glasses

## Laser Targets

- Special reflective surface
- Graduated target (in/cm)
- Magnetic
- Models available for Red or Green lasers



Part#	Description
845	Red Laser Target
845G	Green Laser Target

## Laser Batteries



For 875G laser

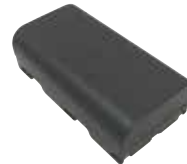

For 883G laser

Part#	Description
875G-B	Replacement Battery for 875G
883G-B	Replacement Battery for 883G

## Laser Detectors with Clamp

- For use with Pulse enabled laser tools for extended ranges
- 9V battery required (not included)
- Models available for Red or Green lasers



Part#	Description
894-04	Red Laser Beam Detector
894-04-G	Green Laser Beam Detector

## Universal Wall Mount

- 2 Strong rare earth magnets
- 2 Hanging holes
- Slot for strap
- 1/4" top thread screw
- 1/4" & 5/8" base thread
- Anti-slip padding



Part#	Description
886-23	Universal Wall Mount

## Multi-functional Magnetic Mount

- Height adjustable mechanism with locking knob
- Double sided graduated scale
- 1/4" & 5/8" threaded bushings for tripod mounting
- 1/4" thread screw
- Rare earth magnets
- V-groove back and bottom
- Clamping unit for pole/pipe mounting also provides additional height adjustment
- Slots for strap mounting



Part#	Description
886-24	Multi-functional Magnetic Mount

# TRIPODS and POLES



**Lightweight Tripod:**

- With vial
- Extends up to 4ft (1.2m)



**Professional Tripod:**

- With scale and vial
- Extends up to 7.5ft (2.32m)

Part#	Description
886-28	Lightweight Tripod

Part#	Description
886-48	Heavy Duty Tripod



**Extendable Pole:**

- Self-clamping between the floor and ceiling
- Telescoping spring loaded tension on one end
- Extends up to 10.5ft (3.2m)
- Includes adjustable laser mount with 5/8" UNC thread

**Pole with Tripod:**

- Telescoping pole with locking sections
- Extends up to 10.5ft (3.2m)
- Strong lightweight tripod stand with surface level
- Adjustable laser mount with 5/8" UNC thread



**Tripod Adapter:**

- Converts tripod thread from 5/8" to 1/4" UNC



**Female to Female Tripod Adapter:**

- 5/8" to 1/4"

Part#	Description
841	1/4" UNC to 5/8" UNC Tripod Adapter
841-02	5/8" Female to 1/4" Female Tripod Adapter
886-30	Extendable Pole for Laser Level Mounting
886-58	Pole with Tripod for Laser Level Mounting

**DISPLAYS and MERCHANDISING**



**227-08D**  
Dimensions:  
11.4" w x 9.5" d x 11" h

**340-08D**  
Dimensions:  
7.7" w x 7.7" d x 9.5" h



**341-D**  
Dimensions:  
8.6" w x 7.9" d x 3.4" h

**724-D**  
Dimensions:  
12" w x 9.5" d x 2" h



Part#	Description
227-08D	9" Toolbox Level 20 pc. Cardboard Display
340-08D	POSTRITE® 6 pc. Cardboard Display

Part#	Description
341-D	Mini Post Level 12 pc. Cardboard Display
724-D	10" Cast Toolbox 12 pc. Cardboard Display

**985D DIGIMAN™ 9 pc. Display**

- Metal display designed to hold 9 Digiman™ Levels in carrying bags
- Ready to assemble



Part#	Description
985D	DIGIMAN™ 9 pc. Display (Products not included)

**905 OPTIVISION® 42 pc. Display**

- Metal display designed to highlight and hold up to 42 Optivision® levels and/or other Kapro items
- Ready to assemble



Part#	Description
905	OPTIVISION® 42 pc. Display (Products not included)

**990 Metal 12 pc. Display**

- Metal display designed to hold a variety of models and sizes of Kapro levels
- Holds up to 12 levels
- Ready to assemble



Part#	Description
990	Metal 12 pc. Display (Products not included)

**DISPLAYS and MERCHANDISING**



1



3



5



2



4

Part#	Description
64195	1. Kapro Banner (36" w x 24" h)
KABANNER	2. Kapro Banner (48" w x 12" h)

Part#	Description
64194	3. Digiman Banner (30" w x 14" h)
64193	4. Kapro Header Sign (24" w x 9" h)
KACARD-L	5. Laser Info Cards - Set of 9 (8.25" w x 5.75" h)

**KAPRO Pegboard Display**  
with pegboard and platform  
• Shelf available (not shown)



Part#	Description
KAW40	Pegboard Display
KAW40-S	Pegboard Shelf (not shown)

**Laser Hanging Display**

- Wire grid panel (2 panels shown)
- Steel shelf with card holder (6 shown)
- Header sign
- Laser info cards available, not included
- Products not included



Part#	Description
64200	Header Sign (24" w x 9" h)
64201	2' x 2' Wire Grid Panel
64202	Steel Shelf with Card Holder
64203	Peg Hooks

**Laser Pole with Tripod Display**

- Pole with Tripod and 5 brackets
- Laser info cards available, not included
- Products not included



Part#	Description
886-59	Pole Laser Display (Products not included)



## Plumb Site® Dual-View™ Vial

Unique front view of the vertical vial

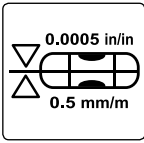

## Precision

< 0.0005"/" (0.5mm/m) in all positions

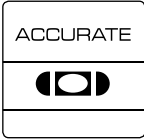

## Accuracy

Solid acrylic vials are individually calibrated



## Solid Acrylic Shockproof Vials

Superior accuracy, readability, and longevity

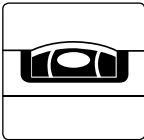

## Magnified Vial

Better readability

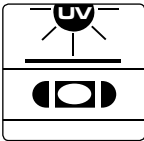

## UV Resistant

Protected from the fading effects of sunlight

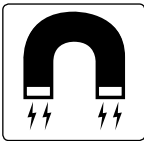

## Magnetic

Powerful magnetic surface for accurate hands-free leveling

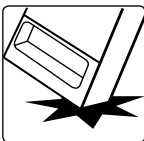

## Shockproof End Caps

Protects the level's integrity and accuracy



## Lifetime Vial Warranty

Solid acrylic vials are guaranteed not to fog, leak, or break



## Angle Finder

Transfer angle measurements



## VPA

Vial accuracy certified by the German VPA laboratory

<b>BOX LEVELS</b>		<b>Pg.</b>	<b>SQUARES and RULERS</b>		<b>Pg.</b>
<b>905D</b>	Condor Digital	<b>4</b>	<b>302</b>	Brass stair gauges	<b>19</b>
	Other Digital Levels	<b>5</b>	<b>305</b>	Steel carpenter square	<b>19</b>
<b>905</b>	Condor	<b>6-7</b>	<b>306</b>	Aluminum rulers	<b>19</b>
<b>985</b>	Apollo	<b>8-9</b>	<b>308</b>	Aluminum straight edges	<b>19</b>
<b>770</b>	Exodus	<b>10</b>	<b>309</b>	Ledgend Try & Mitre sq.	<b>19</b>
<b>779</b>	Spirit	<b>10</b>	<b>316</b>	Drywall T-square	<b>17</b>
<b>781</b>	Genesis	<b>10</b>	<b>317</b>	Adjustable drywall T-sq.	<b>17</b>
<b>995</b>	Vulcan	<b>10</b>	<b>325</b>	Mag. Combination square	<b>17</b>
			<b>352</b>	Combination square	<b>17</b>
<b>I-BEAM LEVELS</b>		<b>Pg.</b>	<b>353</b>	Ledge-It Squares	<b>18</b>
<b>130</b>	Project I-Beam	<b>11</b>	<b>444</b>	Ergocast rafter square	<b>19</b>
<b>150</b>	I-Beam with Plumb Site	<b>11</b>	<b>445</b>	Diecast rafter square	<b>19</b>
<b>170</b>	Samson	<b>11</b>			
<b>CARRY CASES</b>		<b>Pg.</b>	<b>LASER LEVELS</b>		<b>Pg.</b>
		<b>11</b>	<b>896G</b>	Prolaser® Dot-Green	<b>22-23</b>
<b>MASONRY LEVELS</b>		<b>Pg.</b>	<b>862G</b>	Prolaser® 2 Beam-Green	<b>24-25</b>
<b>105</b>	Topgrade gradient levels	<b>12</b>	<b>870G</b>	Prolaser® VHX IP65-Green	<b>26-27</b>
<b>121</b>	Bamboo Wood levels	<b>12</b>	<b>872G</b>	Prolaser® 2 Beam-Green	<b>28-29</b>
<b>720</b>	Supercast levels	<b>13</b>	<b>873G</b>	Prolaser® 3 Beam-Green	<b>30-31</b>
<b>920</b>	Shark levels	<b>13</b>	<b>875G</b>	Prolaser® 5 Beam w/Dot-Gr	<b>32-33</b>
<b>930</b>	Smartcast levels	<b>13</b>	<b>883G</b>	Prolaser® 3 Beam 360°-Gr	<b>34-35</b>
<b>985T</b>	Titan levels	<b>12</b>	<b>962G</b>	Prolaser® 2 Beam 360°-Gr	<b>36-37</b>
			<b>8991G</b>	Prolaser® Rotary IP65-Gr	<b>38-39</b>
			<b>899R</b>	Prolaser® Rotary-Red	<b>40-41</b>
<b>TORPEDO LEVELS</b>		<b>Pg.</b>	<b>LASER ACCESSORIES</b>		<b>Pg.</b>
<b>227</b>	9" Toolbox level w/end caps	<b>14</b>	<b>840</b>	Red Beamfinder glasses	<b>42</b>
<b>229</b>	9" Toolbox level	<b>15</b>	<b>840G</b>	Green Beamfinder glasses	<b>42</b>
<b>724</b>	10" Cast toolbox	<b>14</b>	<b>841</b>	Tripod adapter	<b>43</b>
<b>923</b>	10" Cast toolbox w/Pl. Site	<b>14</b>	<b>841-02</b>	Female tripod adapter	<b>43</b>
<b>925</b>	9" Industrial/Tradesman	<b>14</b>	<b>845</b>	Red laser target	<b>42</b>
<b>929</b>	10" Toolbox w/Pl. Site	<b>15</b>	<b>845G</b>	Green laser target	<b>42</b>
<b>935</b>	10" Optivision Red	<b>14</b>	<b>886-23</b>	Universal wall mount	<b>42</b>
<b>SPECIALTY LEVELS</b>		<b>Pg.</b>	<b>886-24</b>	Multi-functional mount	<b>42</b>
<b>240</b>	Bull's Eye surface level	<b>15</b>	<b>886-28</b>	Tripod (lightweight)	<b>43</b>
<b>242</b>	Cross level	<b>15</b>	<b>886-30</b>	Extendable pole	<b>43</b>
<b>245</b>	Mini-Level	<b>15</b>	<b>886-48</b>	Tripod (professional)	<b>43</b>
<b>246</b>	Handy level	<b>15</b>	<b>886-58</b>	Pole with tripod	<b>43</b>
<b>301</b>	T-Bevel	<b>16</b>	<b>894-04</b>	Red laser beam detector	<b>42</b>
<b>340</b>	Postrite post level	<b>16</b>	<b>894-04G</b>	Green laser beam detector	<b>42</b>
<b>341</b>	Mini post level	<b>16</b>			
<b>350</b>	Pipe level set	<b>16</b>	<b>DISPLAYS &amp; MERCHANDISING</b>		<b>Pg.</b>
<b>846</b>	Cyclops pocket level	<b>15</b>			<b>44-45</b>
<b>946</b>	Smarty level w/Optivision	<b>15</b>			



WORLD CLASS TOOLS SINCE 1876

**Phone: 800-472-8273 | Fax: 800-582-8273**  
**2452 Quakertown Rd., Suite 300**  
**Pennsburg, PA 18073**

**[www.ustape.com](http://www.ustape.com)**

*Not responsible for typographical errors*